



SUSPENSION FORK GLOSSARY

V.1.2_08-2024



MØST

PINARELLO

1

SCOTLAND

PIRELLON

EDITION

GLOSSARY SUSPENSION FORK

OVERVIEW

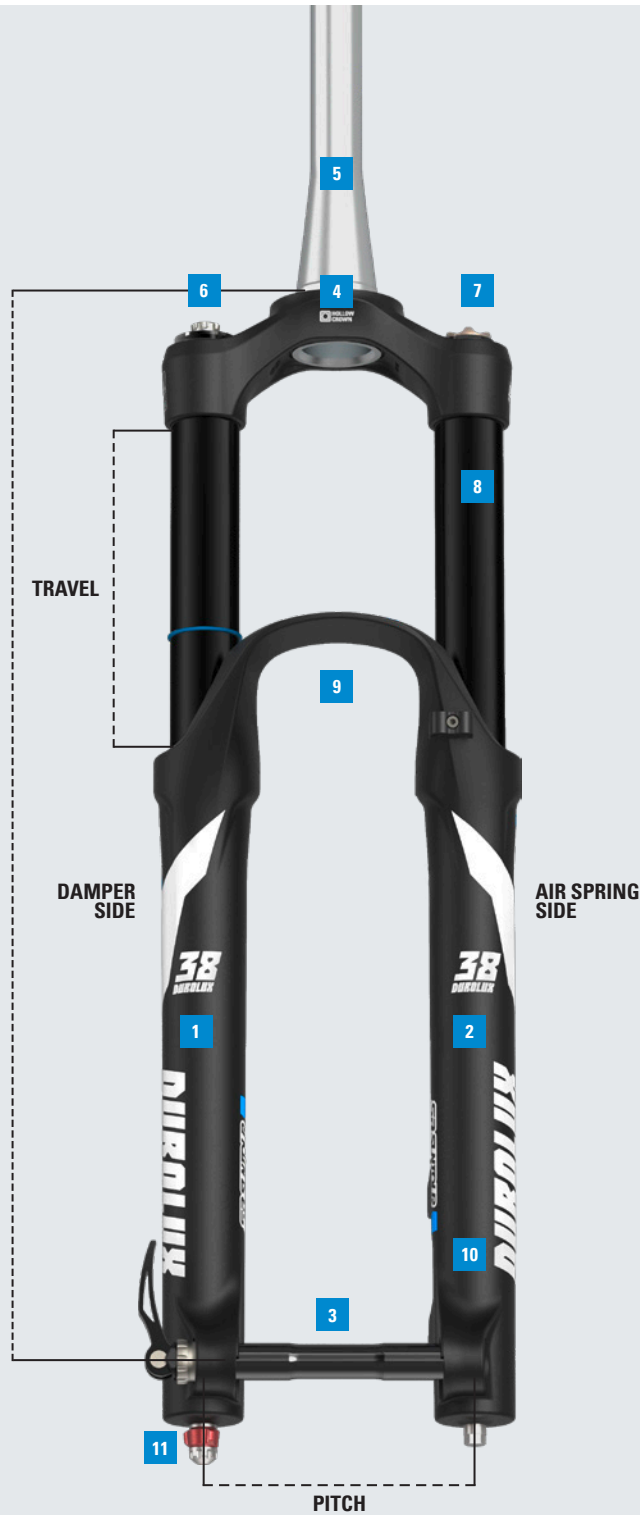

KEY TECHNOLOGIES

- 01 PCS PISTON COMPENSATOR SYSTEM**
MORE TRACTION, CONTROL AND CONSISTENCY
- 02 EQ EQUALIZER SYSTEM**
FOR PRECISE AND EFFORTLESS TUNING
- 03 Q-LOC AND THRU AXLE SYSTEMS**
QUICK RELEASE FOR THRU AXLES
- 04 HOLLOW CROWN**
LIGHTWEIGHT FORGED HOLLOW AND ULTRA-LIGHTWEIGHT CARBON CROWN TECHNOLOGY
- 05 STEERER TUBE**
- 06 COMPRESSION KNOB / LOCK OUT KNOB**
PRELOAD ADJUSTER (NON-DAMPER MODELS)
- 07 AIR VALVE AIR VOLUME ADJUST (AIR MODEL)**
PRELOAD ADJUSTER (COIL MODEL)
- 08 STANCHION TUBE**
- 09 TIRE CLEARANCE**
- 10 BOTTOM CASE / LOWER LEG**
- 11 REBOUND KNOB**



CHECK OUT THE
ONLINE SUSPENSION
FORK GLOSSARY!

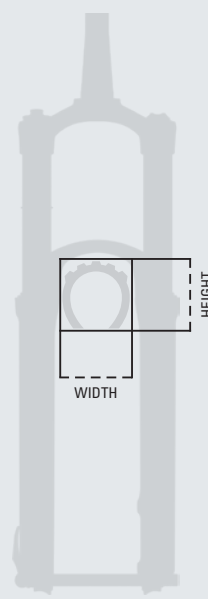

TIRE CLEARANCE



OFFSET

EQ EQUALIZER SYSTEM

FOR PRECISE & EFFORTLESS AIR SPRING TUNING



**WATCH THE
DUROLUX EQ
VIDEO**

LEARN MORE AT WWW.SRSUNTOUR.COM/EQ

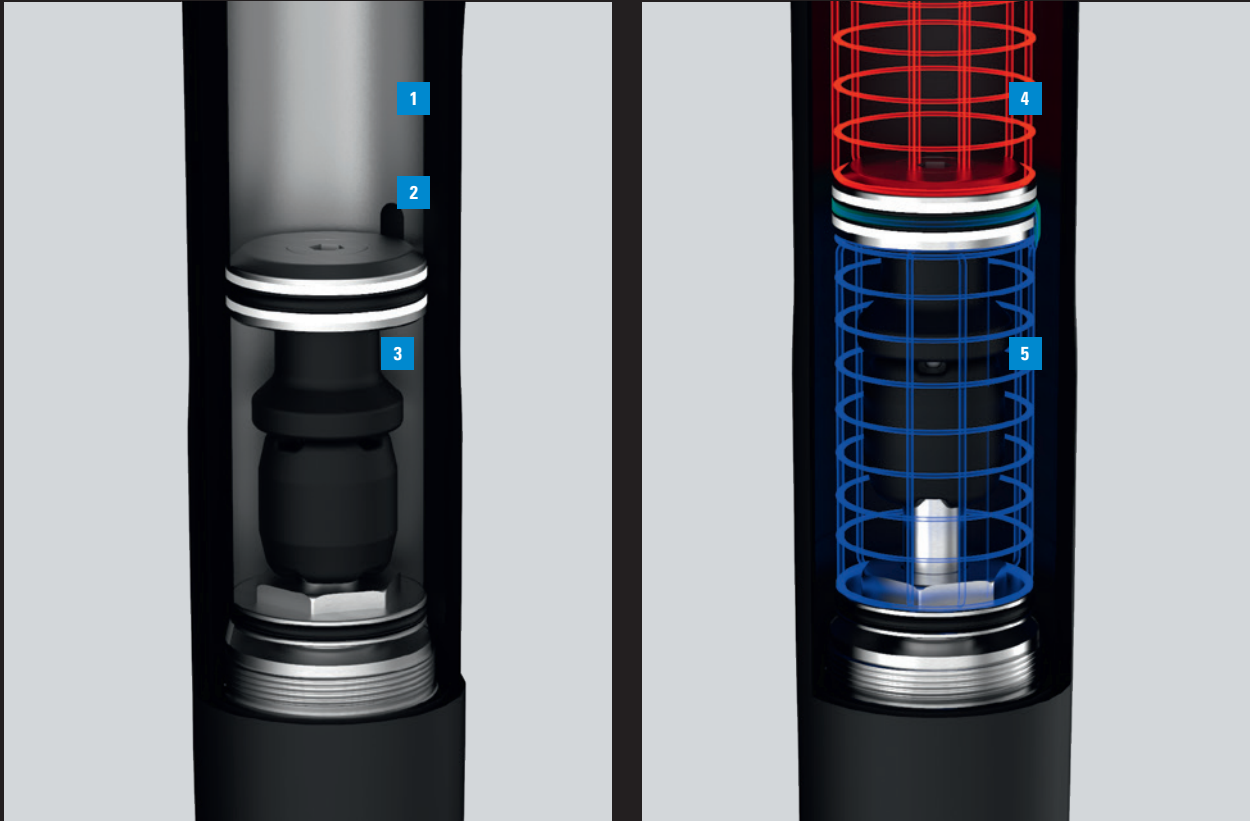

- 1 Positive air chamber
- 2 Transfer port
- 3 Negative air Chamber
- 4 Positive air pressure
- 5 Negative air pressure

SET YOUR SAG AND THE EQUALIZER (EQ) AIR NEGATIVE SPRING SYSTEM WILL BALANCE IT FOR YOU.

Our tradition of product evolution brings our forks into a brand new era with our EQ air system. The EQ system perfectly balances positive and negative spring independent from rider weight, which results in amazing performance and precise support across the range. This customizes feel for each individual rider optimizing SAG and volume control. Pairing the EQ system with the external damping adjustments of our PCS cartridges promise a supple coil spring feel in a lightweight, progressive and easy to adjust air spring package. You can set your SAG according to your intended riding style

and the EQ system will balance it with the right amount of negative spring force helping you to create a precise and effortless tune. The EQ system will improve fork sensitivity of small repetitive bumps while providing plenty of mid-stroke support for those bigger hits resulting in enhanced comfort and performance when riding any kind of terrain.

FUNCTIONAL FEATURES

- Greater, automatic spring adjustability based on the riding style and weight of the rider
- Improved fork sensitivity for those small but fast repetitive bumps
- Super consistent damping performance in tandem with the PCS system

PCS – PISTON COMPENSATOR SYSTEM

MORE TRACTION, CONTROL AND CONSISTENCY



**WATCH THE
PCS VIDEO**

LEARN MORE AT WWW.SRSUNTOUR.COM/PCS

LOW SPEED COMPRESSION



HIGH SPEED COMPRESSION

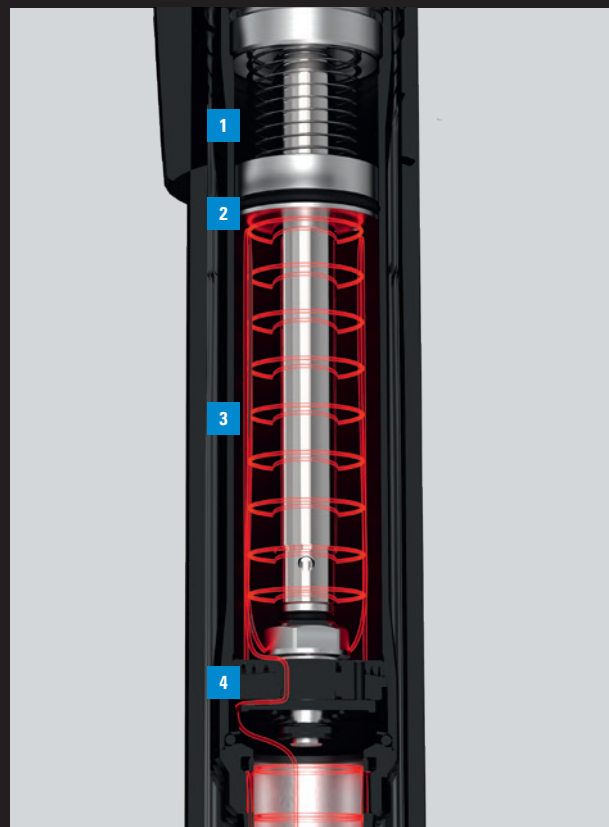

- 1 Air
- 2 PCS avoids vacuum effect
- 3 Oil (Red and blue marked area)
- 4 Piston management of high / low speed compression

THE ULTIMATE IN TRACTION, CONTROL AND CONSISTENCY

With over 20 years of refinement, SR Suntour's Cartridge Science Program has created the most controlled, consistent and functional dampers we've ever produced. PCS is a simple and repeatable way of reducing cavitation (air and oil mixing and creating pressure). Less cavitation means more predictable damping performance, and with cartridges being tested to over 200,000 cycles that performance should last run after run, ride after ride. When it does need servicing, our Quick Service Product (QSP) Philosophy, ensures that you'll spend less time in the work stand and more time on the trail.

3CR PCS

With easy 3-position compression adjustment you can go from open to mid to firm at the touch of a lever. Backed with our PCS system to reduce cavitation you can instantly tune your ride to the terrain. Open: Supportive but ready for big hits, varying terrain and downhills Mid: Extra support for hard charging, technical climbing and undulating terrain Firm: Efficient pedaling for roads, smooth climbing and big sprints.

2CR PCS

Take all the guesswork out of your suspension with easy 2 position on-the-fly adjustment. Whether you choose the fully open position to tame the terrain or the firm position for the utmost in pedaling efficiency the 2CR PCS cartridge has you covered.

PCS CARTRIDGES

RC+-PCS



**INTERNAL SHIM BASED HIGH SPEED COMPRESSION AND REBOUND MANAGEMENT
EXTERNAL LOW SPEED COMPRESSION & REBOUND ADJUST
PCS SYSTEM (PISTON COMPENSATOR SYSTEM)**

Race proven WERX cartridge with PCS (Piston Compensator system) floating piston provides consistent damping in all conditions, eliminating cavitation

- Extra oil flow for high speeds and hard impacts while still offering excellent performance for both small bumps and trail chatter
- High and low speed circuit work independent but transition seamlessly into each other.
- Forged alloy adjust knobs with integrated design
- Updated internal seals greatly improve durability for Trail/AM and Enduro usage
- Light "Click" index feeling for easy and sure operation



R2C2-PCS



**HIGH AND LOW SPEED COMPRESSION ADJUST
HIGH AND LOW SPEED REBOUND
PCS SYSTEM (PISTON COMPENSATOR SYSTEM)**

Race proven WERX cartridge with PCS (Piston Compensator system) floating piston provides consistent damping in all conditions, eliminating cavitation

- High speed compression piston provides a larger adjustable range
- Adjustable high speed rebound design provides fast recovery for improved ride height position
- Updated internal seals greatly improve durability for Trail, Enduro and DH riding
- Forged alloy adjust knobs with integrated design
- Light "Click" index feeling for easy and sure operation

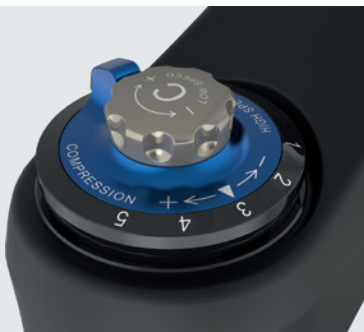

RC2-PCS



**HIGH AND LOW SPEED COMPRESSION ADJUST
REBOUND ADJUST
PCS SYSTEM (PISTON COMPENSATOR SYSTEM)**

Race proven WERX cartridge with PCS (Piston Compensator system) floating piston provides consistent damping in all conditions, eliminating cavitation

- High speed compression piston provides a larger adjustable range
- Updated internal seals greatly improve durability for Trail, Enduro and DH riding
- Forged alloy adjust knobs with integrated design
- Light "Click" index feeling for easy and sure operation

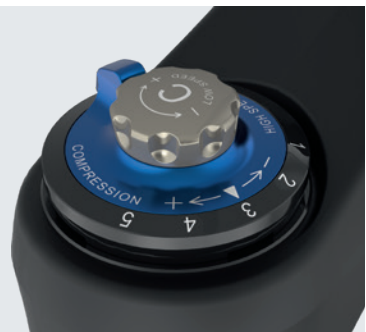

RC-PCS



**LOW SPEED COMPRESSION
ADJUST
REBOUND ADJUST
PCS SYSTEM
(PISTON COMPENSATOR
SYSTEM)**

Race proven WERX cartridge with PCS (Piston Compensator system) floating piston provides consistent damping in all conditions, eliminating cavitation

- Updated internal seals greatly improve durability for Trail, Enduro and DH riding
- Forged alloy adjust knobs with integrated design
- Light "Click" index feeling for easy and sure operation



R-3CR-PCS



**3 POSITIONS OF
COMPRESSION ADJUST
LOW SPEED REBOUND ADJUST
REMOTE LOCK OUT
PCS SYSTEM (PISTON
COMPENSATOR SYSTEM)**

Race proven WERX cartridge with PCS (Piston Compensator system) floating piston provides consistent damping in all conditions, eliminating cavitation

- Remote actuated 3 step (firm, medium, open) low speed compression adjustment. Low speed rebound damping adjust
- Forged alloy adjust knobs with integrated design
- Ergonomic design remote lock lever for faster and easier operation



R-2CR-PCS



**2 POSITIONS OF
COMPRESSION ADJUST
LOW SPEED REBOUND ADJUST
REMOTE LOCK OUT
PCS SYSTEM (PISTON
COMPENSATOR SYSTEM)**

Race proven WERX cartridge with PCS (Piston Compensator system) floating piston provides consistent damping in all conditions, eliminating cavitation

- Remote actuated 2 step (firm, open) low speed compression adjustment. Low speed rebound damping adjust
- Forged alloy adjust knobs with integrated design
- Ergonomic design remote lock lever for faster and easier operation



2CR-PCS



2 POSITIONS OF COMPRESSION ADJUST LOW SPEED REBOUND ADJUST PCS SYSTEM (PISTON COMPENSATOR SYSTEM)

Race proven WERX cartridge with PCS (Piston Compensator system) floating piston provides consistent damping in all conditions, eliminating cavitation

- 2 step (firm, open) low speed compression adjustment. Low speed rebound damping adjust
- Updated internal seals greatly improve durability for Trail, Enduro riding
- Light "Click" index feeling for easy and sure operation



3CR-PCS



3 POSITIONS OF COMPRESSION ADJUST LOW SPEED REBOUND ADJUST PCS SYSTEM (PISTON COMPENSATOR SYSTEM)

Race proven WERX cartridge with PCS (Piston Compensator system) floating piston provides consistent damping in all conditions, eliminating cavitation

- 3 step (firm, medium, open) low speed compression adjustment. Low speed rebound damping adjust.
- Updated internal seals greatly improve durability for Trail, Enduro and DH riding
- Light "Click" index feeling for easy and sure operation



RLRC-PCS



LOW SPEED COMPRESSION ADJUST REBOUND ADJUST REMOTE SPEED LOCK PCS SYSTEM (PISTON COMPENSATOR SYSTEM)

Race proven WERX cartridge with PCS (Piston Compensator system) floating piston provides consistent damping in all conditions, eliminating cavitation

- 3 in 1 function: Lock out, low speed compression adjust & rebound adjust in one cartridge.
- Drastic improvement of riding efficiency & its adjustability for cross country & trail ride
- Forged alloy adjust knobs with integrated design
- Updated internal seals greatly improve durability for Trail, Enduro and DH riding
- Light "Click" index feeling for easy and sure operation
- Ergonomic design remote lock lever for faster and easier operation



RLR-PCS



**REBOUND ADJUST
REMOTE SPEED LOCK
PCS SYSTEM (PISTON
COMPENSATOR SYSTEM)**

Race proven WERX cartridge with PCS (Piston Compensator system) floating piston provides consistent damping in all conditions, eliminating cavitation

- Hydraulic Remote Lockout
- Drastic improvement of riding efficiency & its adjustability for cross country & trail ride
- Forged alloy adjust knobs with integrated design
- Updated internal seals greatly improve durability for Trail, Enduro and DH riding
- Light "Click" index feeling for easy and sure operation



LORC-PCS



**LOW SPEED COMPRESSION
ADJUST
REBOUND ADJUST
SPEED LOCK
PCS SYSTEM (PISTON
COMPENSATOR SYSTEM)**

Race proven WERX cartridge with PCS (Piston Compensator system) floating piston provides consistent damping in all conditions, eliminating cavitation

- 3-in-1 Lock out + low speed compression & rebound adjust in one cartridge
- Drastic improvement of riding efficiency & its adjustability for cross country & trail ride
- Forged alloy adjust knobs with integrated design
- Updated internal seals greatly improve durability for Trail, Enduro and DH riding
- Light "Click" index feeling for easy and sure operation



LOR-PCS



**2 POSITIONS OF
COMPRESSION ADJUST
LOW SPEED REBOUND
ADJUST
PCS SYSTEM (PISTON
COMPENSATOR SYSTEM)**

Race proven WERX cartridge with PCS (Piston Compensator system) floating piston provides consistent damping in all conditions, eliminating cavitation

- Hydraulic Lockout with adjustable rebound damping with blow off feature.
- Forged alloy adjust knobs with integrated design
- Updated internal seals greatly improve durability for Trail, Enduro and DH riding
- Light "Click" index feeling for easy and sure operation



DAMPING ADJUSTMENT



RC+



R2C2-PCS



RC2-PCS

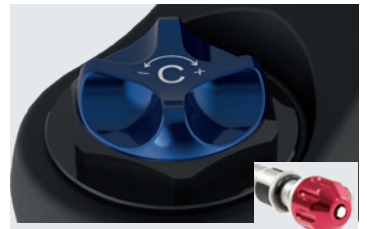

RC-PCS



R-3CR-PCS



R-2CR-PCS



3CR-PCS



2CR-PCS



1

2CR-PCS



RLRC-PCS



RLR-PCS



LORC-PCS



LOR-PCS



2CR



2CR



2CR

NAME	FUNCTION
RC+	External low speed compression and rebound adjustment, internal shim based high speed compression and rebound management.
R2CR-PCS	High & low speed compression and high & low speed rebound damping adjusts with blow-off feature along with PCS system.
RC2-PCS	High & low speed compression and low speed rebound damping adjusts with blow-off feature along with PCS system.
RC-PCS	Low speed compression and low speed rebound damping adjusts with blow-off feature along with PCS system.
R-3CR-PCS	Remote Lockout with 3 positions of compression (firm setting, medium setting and open setting) with low speed rebound adjust along with PCS system.
R-2CR-PCS	Remote Lockout with 2 positions of compression (firm setting and open setting) with low speed rebound adjust along with PCS system.
3CR-PCS	3 positions of compression (firm setting, medium setting and open setting) with low speed rebound adjust along with PCS system.
2CR-PCS	2 positions of compression (firm setting and open setting) with low speed rebound adjust along with PCS system.
RLRC-PCS	Hydraulic Remote Lockout with low speed compression and low speed rebound damping adjusts with blow-off feature along with PCS system.
RLR-PCS	Hydraulic Remote Lockout with rebound damping adjusts with blow-off feature along with PCS system.
LORC-PCS	Hydraulic Lockout with low speed compression and low speed rebound damping adjusts with blow-off feature along with PCS system.
LOR-PCS	Hydraulic Lockout with adjustable rebound damping with blow-off feature along with PCS system.

NAME	FUNCTION
RC2	High & low speed compression and low speed rebound damping adjusts with blow-off feature.
RC	Low speed compression and low speed rebound damping adjusts with blow-off feature.
3CR	3 position of compression (firm setting, medium setting and open setting) with low speed rebound adjust.
2CR	2 positions of compression (firm setting and open setting) with low speed rebound adjust.
RLRC	Hydraulic Remote Lockout with adjustable rebound and compression damping with blow-off feature.
LORC	Hydraulic Lockout with adjustable rebound and compression damping with blow-off feature.
RLR	Hydraulic Remote Lockout with adjustable rebound damping with blow-off feature.
LOR	Hydraulic Lockout with adjustable rebound damping with blow-off feature.
RL	Hydraulic Remote Lockout with fixed rebound damping with blow-off feature.
LO	Hydraulic Lockout with fixed rebound damping with blow-off feature.
NLO	Hydraulic Lockout with fixed rebound damping.
HLO	Hydraulic Lockout without rebound damping.

¹ SF22-MOBIE35-BOOST-EQ-2CR-PCS-27.5"/29", ² SF23-RAIDON34-BOOST-2CR-27.5"/29" / SF23-XCR34-BOOST-COIL-2CR-27.5"/29" / SF23-XCR34-BOOST-AIR-2CR-27.5"/29" ³ SF21-MOBIE34-D-2CR-27.5"/700C

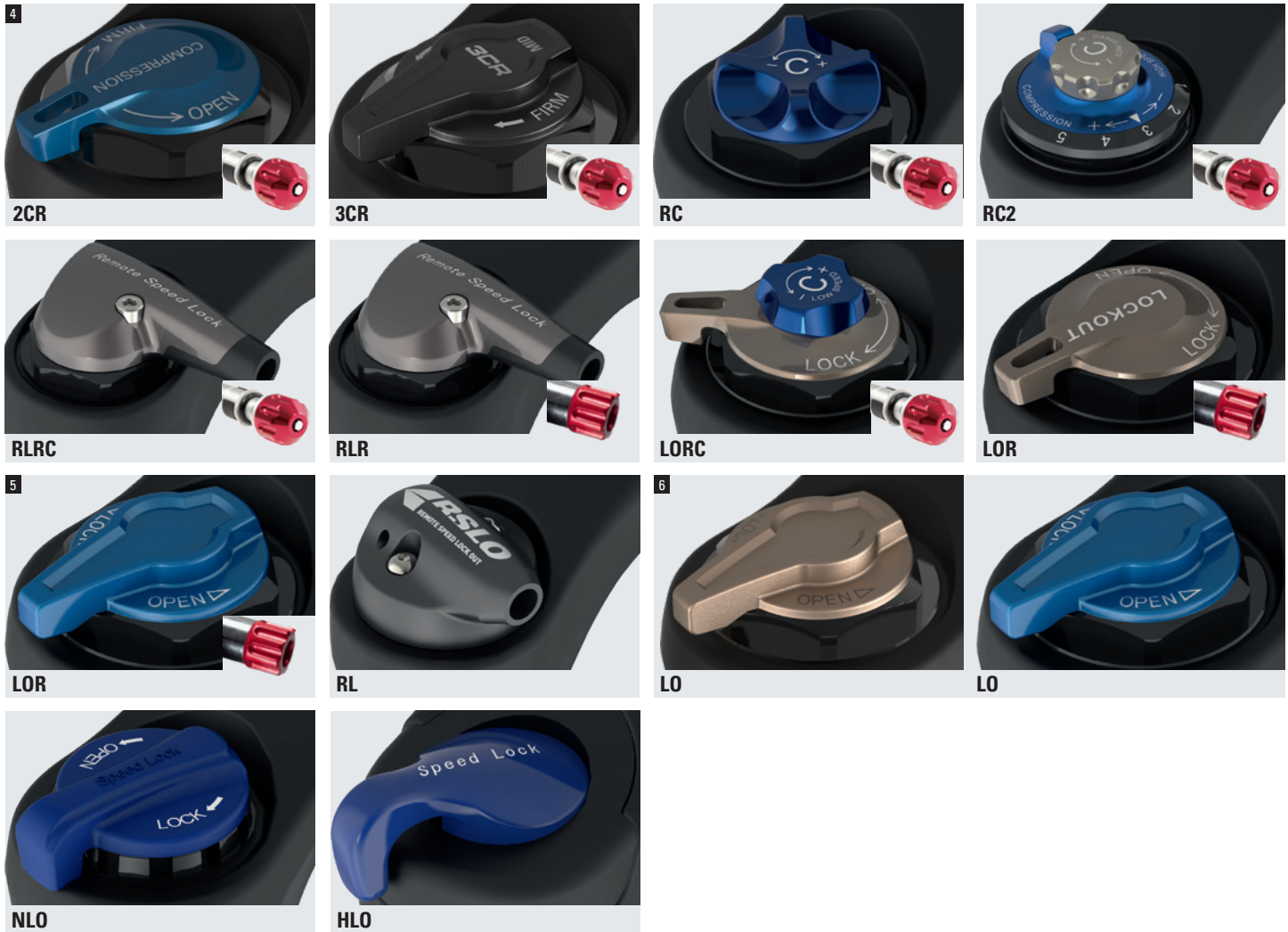

APPLICATION TABLE	RC+	R2C2	RC2	3CR	2CR	RC	R-3CR	R-2CR	RLRC	LORC	RLR	LOR	RL	LO	HLO	NLO
RUX	-	●	●	-	-	-	-	-	-	-	-	-	-	-	-	-
DUROLUX	●	●	●	-	-	●	-	-	-	-	-	-	-	-	-	-
AURON	●	-	-	-	-	-	-	-	-	-	-	-	-	-	-	-
AION	-	-	-	●	●	●	-	-	-	●	-	-	-	-	-	-
ZERON	-	-	-	●	●	●	-	-	-	●	●	-	-	-	-	-
AXON	-	-	-	-	-	-	-	-	●	●	-	-	-	-	-	-
RAIDON	-	-	-	-	●	-	-	●	-	-	●	●	-	-	-	-
XCR	-	-	-	-	●	-	-	●	-	-	●	●	●	●	-	-
EIXON32	-	-	-	-	●	-	-	●	-	-	-	●	●	●	-	-
X1	-	-	-	-	-	-	-	-	-	-	●	●	●	●	-	-
XCM	-	-	-	-	-	-	-	-	-	-	-	●	●	●	●	●
XCT	-	-	-	-	-	-	-	-	-	-	-	-	-	-	●	●
MOBIE36	-	-	-	●	●	-	-	-	-	●	-	-	-	-	-	-
MOBIE35	-	-	-	●	●	-	-	-	-	-	-	-	-	-	-	-
MOBIE34	-	-	-	-	●	-	-	●	-	-	-	-	-	-	-	-
MOBIE34 CGO	-	-	-	-	●	-	-	●	-	-	-	-	-	●	-	-
MOBIE25	-	-	-	-	-	-	-	-	-	-	●	●	-	-	-	-
MOBIEA32	-	-	-	-	-	-	-	-	-	-	-	-	●	●	-	●
GVX	-	-	-	-	-	-	-	-	-	-	●	●	-	-	-	-
NRX	-	-	-	-	-	-	-	-	-	-	●	●	-	-	-	-
NCX32/NCX	-	-	-	-	-	-	-	-	-	-	-	-	●	●	-	-
NX1/TR-HSI	-	-	-	-	-	-	-	-	-	-	-	-	●	●	●	-
NVX	-	-	-	-	-	-	-	-	-	-	-	-	●	-	-	●
NEX	-	-	-	-	-	-	-	-	-	-	-	-	●	-	●	●
CR85	-	-	-	-	-	-	-	-	-	-	-	-	-	●	-	-

● PCS CARTRIDGE

* SF21MOBIE34-2CR-27.5/700C, * SF19-XCR32-BOOST-COIL-LOR 27.5/29" / SF19-XCR32-BOOST-AIR-LOR 27.5/29" / SF18-XCR34-BOOST-COIL-LOR 27.5/29" / SF18-XCR34-BOOST-AIR-LOR 27.5/29" / SF19-RAIDON32-BOOST-LOR 27.5/29" / SF18-RAIDON34-BOOST-LOR 27.5/29", * SF19-XCR32-BOOST-COIL-LO-27.5/29" / SF19-XCR32-BOOST-AIR-LO-27.5/29" / SF18-XCR34-BOOST-COIL-LO-27.5/29" / SF18-XCR34-BOOST-AIR-LO-27.5/29"

SPRING SYSTEM



AIR EQ (1) / AIR(2)
Dual air spring system / Standard air spring



AIR EQ (3) / AIR (4)
Dual air spring system / Standard air spring



AIR EQ (5)
Dual air spring system



AIR EQ (6) / AIR(7)
Dual air spring system / Standard air spring



COIL ADJUSTABLE
Coil spring with adjustable preload



COIL
Coil spring

APPLICATION TABLE	AIR EQ (1)	AIR (2)	AIR EQ (3)	AIR (4)	AIR EQ (5)	AIR EQ (6)	AIR (7)	COIL ADJUSTABLE	COIL
RUX	-	-	●	-	-	-	-	-	-
DUROLUX	●	-	-	-	●	-	-	-	-
AURON	●	-	-	-	-	-	-	-	-
AION	-	-	-	-	●	-	-	-	-
ZERON	-	-	-	-	●	-	-	●	-
AXON	-	●	●	-	-	-	-	-	-
RAIDON	-	-	-	-	-	●	●	-	-
XCR	-	-	●	-	-	-	●	●	-
EPIXON32	-	-	-	-	-	-	●	-	-
X1	-	-	-	-	-	-	●	●	-
XCM	-	-	-	-	-	-	-	●	-
XCT	-	-	-	-	-	-	-	●	-
XCE	-	-	-	-	-	-	-	●	-
M3010	-	-	-	-	-	-	-	●	●
MOBIE36	-	-	-	-	●	-	-	-	-
MOBIE35	-	-	-	-	●	-	-	-	-
MOBIE34/25	-	-	-	●	●	-	●	●	-
MOBIEA32	-	-	-	-	-	-	-	●	-
GVX	-	-	●	-	-	-	-	-	-
NRX	-	-	-	-	-	-	-	●	-
NCX32/NCX	-	-	-	-	-	-	-	●	-
NX1/TR-HSI	-	-	-	-	-	-	-	●	-
NVX	-	-	-	-	-	-	-	●	-
NEX	-	-	-	-	-	-	-	●	-
CR85	-	-	-	-	-	-	-	●	-

ADJUSTABLE AIR CHAMBER VOLUME

VOLUME SPACER LOGIC

Adjust your spring curve by using different amount of rubber volume spacers. This function allows the rider to choose between a more linear or a more progressive characteristic curve. More spacers for more progression. Less spacers for more comfort. Visit www.srsuntour.com for tech videos and product manuals with detailed information.

Air spring curve can be widely adjustable, which can bring the extra comfort wider range of total weight of "bike + rider + luggage".



EXAMPLE FOR SPACER SETUP

RIDING STYLE	RIDER WEIGHT	55-65 Kg	65-75 Kg	75-85 Kg
	Pressure 25% Sag	55 PSI	65 PSI	75 PSI
Aggressive				
Balanced				
Easy	No Spacer			

EXAMPLE SPRING CHARACTERISTIC: DUROLUX EQ 29, 160mm travel

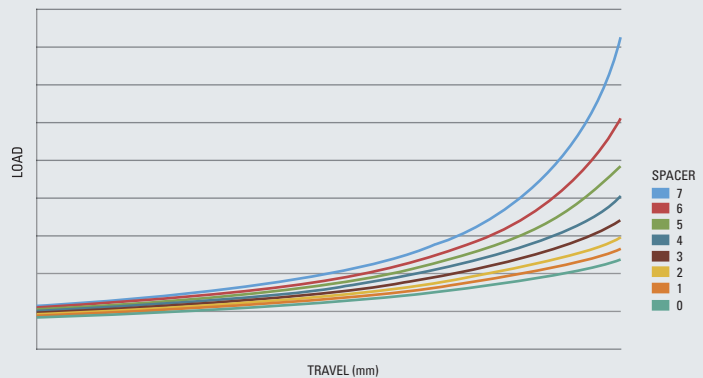

STANCHION

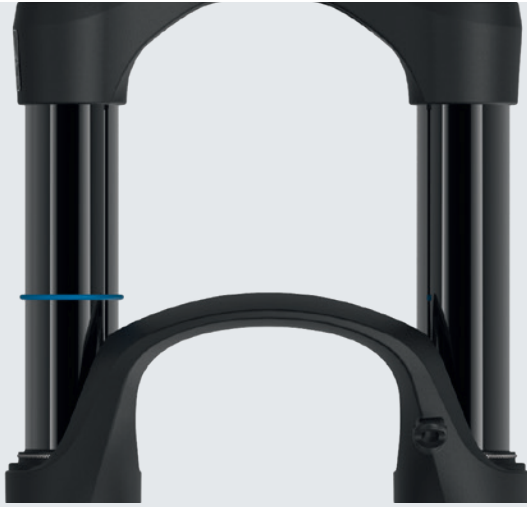

HARD ANODIZED BLACK A7 / A6000 series aluminum

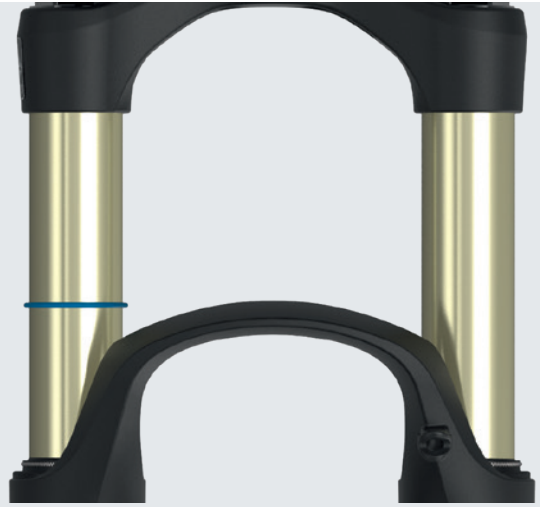

HARD ANODIZED GOLD A7 / A6000 series

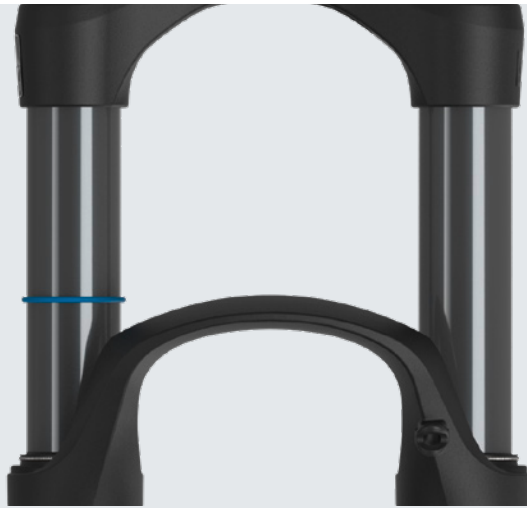

BLACK STKM

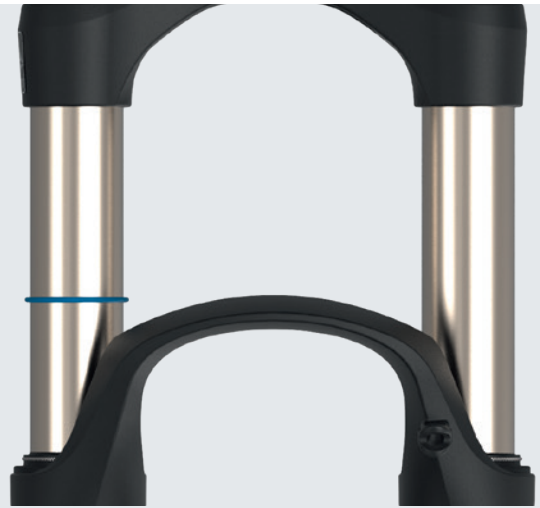

NI-PLATING STKM

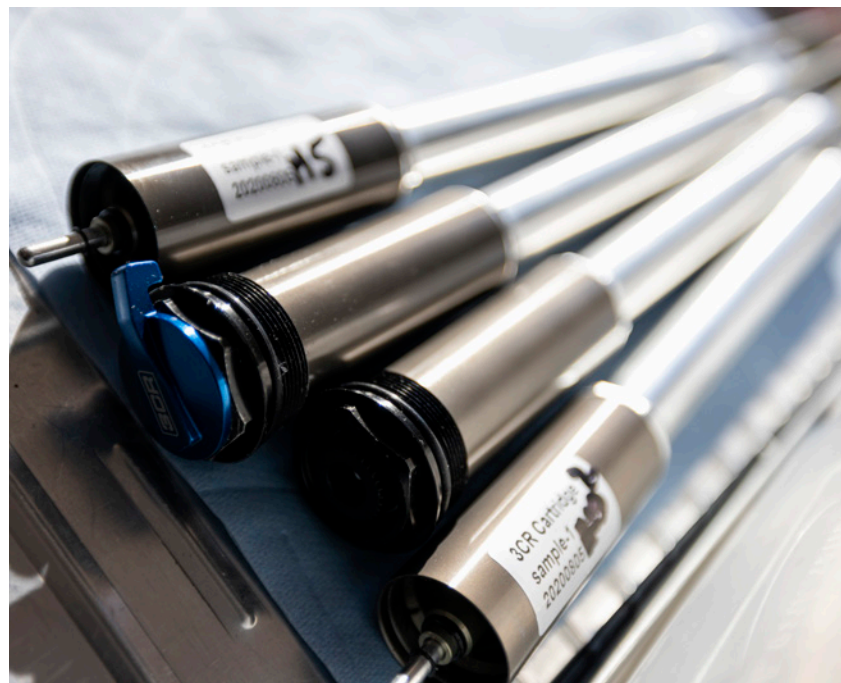
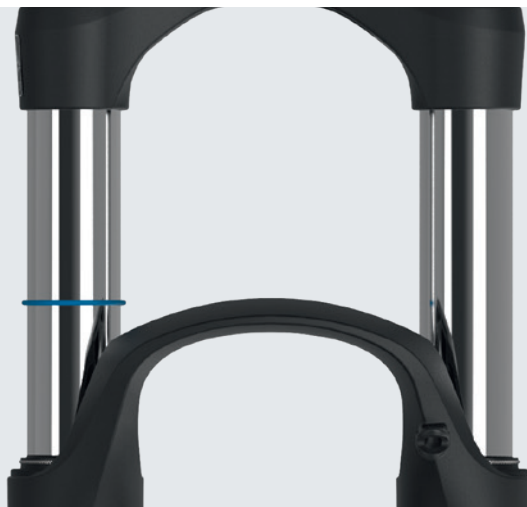

BOTTOM CASE COLORS



MATT BLACK
Color code YS727



GLOSS BLACK
Color code YS728



METALLIC SLATE
Color code YS941



GLOSS WHITE
Color code YS701

DECALS



COMPANY COLOR
Black



COMPANY COLOR
White



METALLIC SLATE
Metallic Gray



STEALTH
with glossy decal



STEALTH
with matt decal

Q-LOC AND THRU AXLE SYSTEMS



Q-LOC is a patented quick release system for thru axles fully deserving of the name "quick". Q-LOC 2 is the logical evolutionary step, guaranteeing 100% compatibility with all kinds of hub axle designs. A simple push and a little twist of the nut enables a quick removal of the axle. Exchanging the axle is as fast as extracting the axle thanks to the patented expander design which smoothly passes the thru axle and latches safely with a reassuring click sound. Safety and speed is crucial when it comes to pressurised wheel changes during a race. Q-LOC2 offers both in a super lightweight axle (Q-LOC2-Ti 70g).



20QLC2
 Ø20mm, O.L.D.: 110mm
 Weight: 140g



20LH-110
 Ø20mm, O.L.D.: 110mm
 Weight: 96g



15QLC2Ti / 15QLC2Ti-110
 Ø15mm, O.L.D.: 100mm / 110mm
 Weight: 68g / 71g



15QLC2 / 15QLC2-110
 Ø15mm, O.L.D.: 100mm / 110mm
 Weight: 112g/115g



15QLC32 / 15QLC32-110
 Ø15mm, O.L.D.: 100mm / 110mm
 Weight: 118g / 122g



15QLC32S
 Ø15mm, O.L.D.: 100mm
 Weight: 108g



15AH2 / 15AH2-110 (TOOL TYPE)
 Ø15mm, O.L.D.: 100mm / 110mm
 Weight: 50g / 55g



15LH / 15LH-110
 Ø15mm, O.L.D.: 100mm / 110mm
 Weight: 88g / 91g



12AH2 (TOOL TYPE)
 Ø12mm, O.L.D.: 100mm



QR (TOOL FREE)
 Ø20mm, O.L.D.: 110mm
 Weight: 120g



T (TOOL TYPE)
 Ø20mm, O.L.D.: 110mm
 Weight: 120g

ASSEMBLY INSTRUCTIONS

REMOVE QLOC



INSERT QLOC



WATCH THE VIDEO TUTORIAL!

APPLICATION TABLE	T	QR	15AH2	15LH / 15LH-110	12AH	15AH2-110	20QLC2	20QLC2-110	20LH-110	15QLC2	15QLC2-110	15QLC32	15QLC32-110	15QLC2Ti	15QLC2Ti-110	15QLC32S
RUX	●	○	-	-	-	-	-	-	-	-	-	-	-	-	-	-
DUROLUX38	-	-	-	○	-	●	-	-	-	-	-	-	-	-	-	-
DUROLUX36	-	-	-	○	-	●	-	-	-	-	-	-	-	-	-	-
AURON	-	-	-	○	-	●	-	-	-	-	-	-	-	-	-	-
AION	-	-	-	○	-	●	-	-	-	-	-	-	-	-	-	-
ZERON	-	-	-	○	-	●	-	-	-	-	-	-	●	-	-	-
AXON34 WERX/ELITE	-	-	-	-	-	-	-	-	-	-	-	-	-	-	●	-
AXON34	-	-	-	○	-	●	-	-	-	-	-	-	-	-	-	-
AXON32	-	-	-	-	-	-	-	-	-	-	●	-	-	-	-	-
RAIDON34	-	-	-	○	-	●	-	-	-	-	-	-	-	-	-	-
RAIDON32	-	-	-	-	-	-	-	-	-	-	-	-	●	-	-	-
XCR	-	-	-	●	-	-	-	-	-	-	-	-	●	-	-	-
XCM	-	-	●	-	-	●	-	-	-	-	-	○	○	-	-	-
X1	-	-	-	-	-	●	-	-	-	-	-	-	-	-	-	-
MOBIE36	-	-	-	○	-	●	-	-	-	-	-	-	-	-	-	-
MOBIE34/25	-	-	●	-	-	●	-	-	-	-	-	●	-	-	-	-
MOBIEA32	-	-	●	-	-	-	-	-	-	-	-	-	-	-	-	-
GVX	-	-	●	-	○	-	-	-	-	-	-	-	-	-	-	-
NRX	-	-	●	-	-	-	-	-	-	-	-	-	-	-	-	●
NX1	-	-	●	-	-	-	-	-	-	-	-	-	-	-	-	-
NVX	-	-	●	-	-	●	-	-	-	-	-	-	-	-	-	-
NCX	-	-	-	-	-	-	-	-	-	-	-	-	-	-	-	●
NEX-E25	-	-	-	-	-	-	-	-	-	-	-	-	-	-	-	●

● standard ○ optional

FEATURE	15QLC2Ti / 15QLC2Ti-110	15QLC2 / 15QLC2-110	15QLC32 / 15QLC32-110	15QLC32S	15LH / 15LH-110	20QLC	20LH-110	15AH2 / 15AH2-110 (TOOL TYPE)
ONE TOUCH RELEASE DESIGN	Yes	Yes	Yes	Yes	No	Yes	No	No
QUICK LEVER	Alloy with CNC machined hole	Alloy with print	Alloy with print	Alloy with print	Alloy with print	Alloy with print	Alloy with print	-
COMPATIBLE O.L.D.	100mm / 110mm	100mm / 110mm	100mm / 110mm	100mm	100mm / 110mm	110mm	110mm	100mm / 110mm
THROUGH AXLE DIAMETER	15mm	15mm	15mm	15mm	15mm	20mm	20mm	15mm
THROUGH AXLE MATERIAL	Alloy (A7075)	Alloy	Cr-mo	Alloy	Alloy	Cr-mo	Alloy	Alloy
QUICK AXLE MATERIAL	Titanium	Cr-mo	Cr-mo	Cr-mo	Cr-mo	Cr-mo	Cr-mo	-
WEIGHT	70g / 72g	112g / 116g	118g / 122g	108g	88g / 91g	140g	96g	NA
PART CODE	FKA069-15	FKA069-05	FKA069-25/26	FKA097-25/26	FKA116-12/ 02	FKA068-05	FKA123-00	FKA117-02/00

LIGHTWEIGHT HOLLOW CROWN



HOLLOW CROWN

HOLLOW CROWN TECHNOLOGY
Lightweight forged Hollow Crown Technology



CARBON

CARBON CROWN TECHNOLOGY
Ultra-Lightweight Carbon Crown

STEERER TUBE



1.5"-1 1/8" TAPER
CTS (Conical Tapered Steerer)
Upper 1-1/8", Lower 1.5"
Material: Alloy / Carbon / STKM



1.8"-1 1/8" TAPER
CTS (Conical Tapered Steerer)
Upper: 1-1/8", Lower 1.8" Material: Alloy

1.8" TAPER
CTS (Conical Tapered Steerer)
only C74 (74mm crown size)



1-1/8"
TS: Upper 1-1/8"
Material: Alloy / cr-mo / STKM

STANCHION DIAMETER



WHEEL SIZE

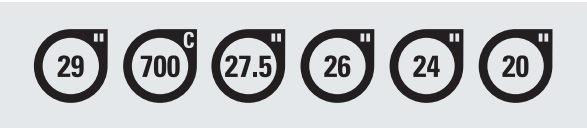

BRAKE TYPE



P
PIVOT BRAKE TYPE AKA. V-BRAKE



DS
POSTMOUNT DISC BRAKE TYPE



FDS
FLAT MOUNT DISC BRAKE TYPE

ABS MOUNT



MODELS WITH ABS SENSOR MOUNT:

DUROLUX38X-EVO-Boost
AION38X/36X-Boost
ZERON36X-Boost
MOBIE36/34-Boost
MOBIE34-D-Boost
MOBIE34

MODELS WITH ABS MOUNT:

DUROLUX38X-EVO-Boost
AION38X/36X-Boost
ZERON36X-Boost
MOBIE36/34-Boost
MOBIE34-D-Boost
MOBIE34

For detailed information regarding ABS systems and brake options, please rely on the information provided by the related ABS or brake systems manufacturers.

HEAD LAMP MOUNT



INTEGRATED TYPE ON FORK CROWN
With smooth cable routing



INTEGRATED TYPE ON FORK BRACE



UNIVERSAL MOUNT
Bolt-on

CABLE GUIDE



HUB DYNAMO CABLE GUIDE
w/screws *Option

APPLICATION TABLE	ON FORK CROWN	ON FORK BRACE	UNIVERSAL MOUNT	CABLE GUIDE HUB DYNAMO
XCR32-ATB	●	-	-	-
EPIXON32	●	-	-	-
XCM32-ATB	●	-	-	-
XCT	-	-	●	-
XCE	-	-	●	-
M3010	-	-	●	●
MOBIE36/35/34/25/A32	●	-	-	-
NCX	-	●	-	●
NCX32	●	-	-	-
NVX	●	-	-	-
NX1	-	●	-	-
NEX-E25-C	●	-	-	●
NEX-E25	-	●	-	●
NEX	-	●	-	●
TR-HSI	-	-	●	-
CR85-25	-	●	●	●

SHORT FENDER



SHORT FENDER MOUNT
Detachable integrated short fender

APPLICATION TABLE	SHORT FENDER TYPE
RUX BOOST	●
DUROLUX BOOST	●
AURON BOOST	●
AION BOOST	●
ZERON36/35 BOOST	●
AXON34 WERX/ELITE BOOST	●
AXON34/32 BOOST	●
RAIDON34/32 BOOST	●
RAIDON	-
XCR34/32 BOOST	●
XCR	-
XCR32-ATB	-
X1-BOOST	●
XCM32/30	-
XCM32-ATB	-
XCM34	●
XCT	-
XCE	-
M3010	-
MOBIE36/34 BOOST	●
MOBIE34/25/A32	-
GVX	●
NRX	-
NCX	-
NVX30	-
NX1	-
NCX32	-
NVX	-
NEX	-
CR85-25	-

LONG FENDER MOUNTS

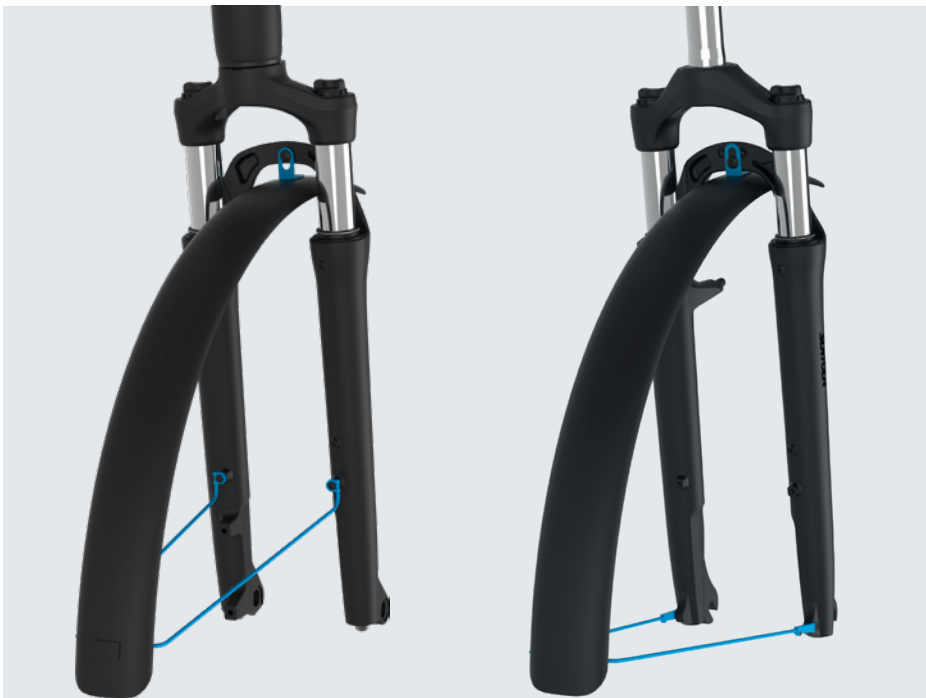

LONG FENDER TYPE
Disc brake type

LONG FENDER TYPE
V-brake

APPLICATION TABLE	LONG FENDER TYPE DISC BRAKE	LONG FENDER TYPE V-BRAKE
RUX BOOST	-	-
DUROLUX BOOST	●	-
AURON BOOST	●	-
AION BOOST	●	-
ZERON36/35 BOOST	●	-
AXON34 WERX/ELITE BOOST	-	-
AXON34/32 BOOST	●	-
RAIDON34/32 BOOST	●	-
RAIDON	●	-
XCR34/32 BOOST	●	-
XCR	●	-
XCR32-ATB	●	-
X1-BOOST	●	-
XCM32/30	●	-
XCM32-ATB	●	-
XCM34	●	-
XCT	-	-
XCE	-	-
M3010	-	●
MOBIE36/34 BOOST	●	-
MOBIE34/25/A32	●	-
GVX	●	-
NRX	●	-
NCX	●	-
NVX30	●	-
NX1	●	-
NCX32	●	-
NVX	●	-
NEX	●	●
CR85-25	●	●

